

SIMBOLOGIA

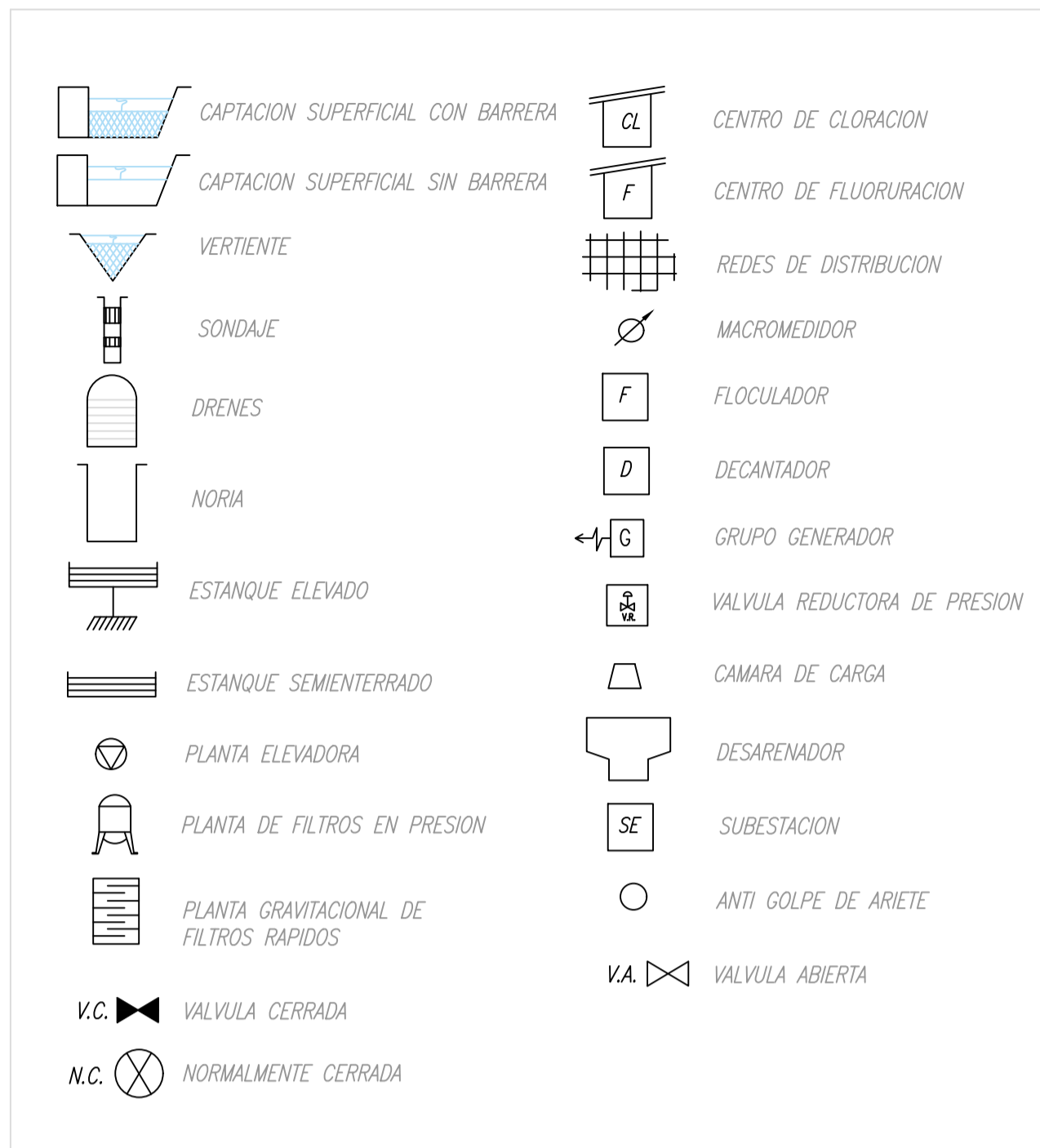

SISTEMA DE PRODUCCIÓN – DISTRIBUCIÓN
LA TIRANA

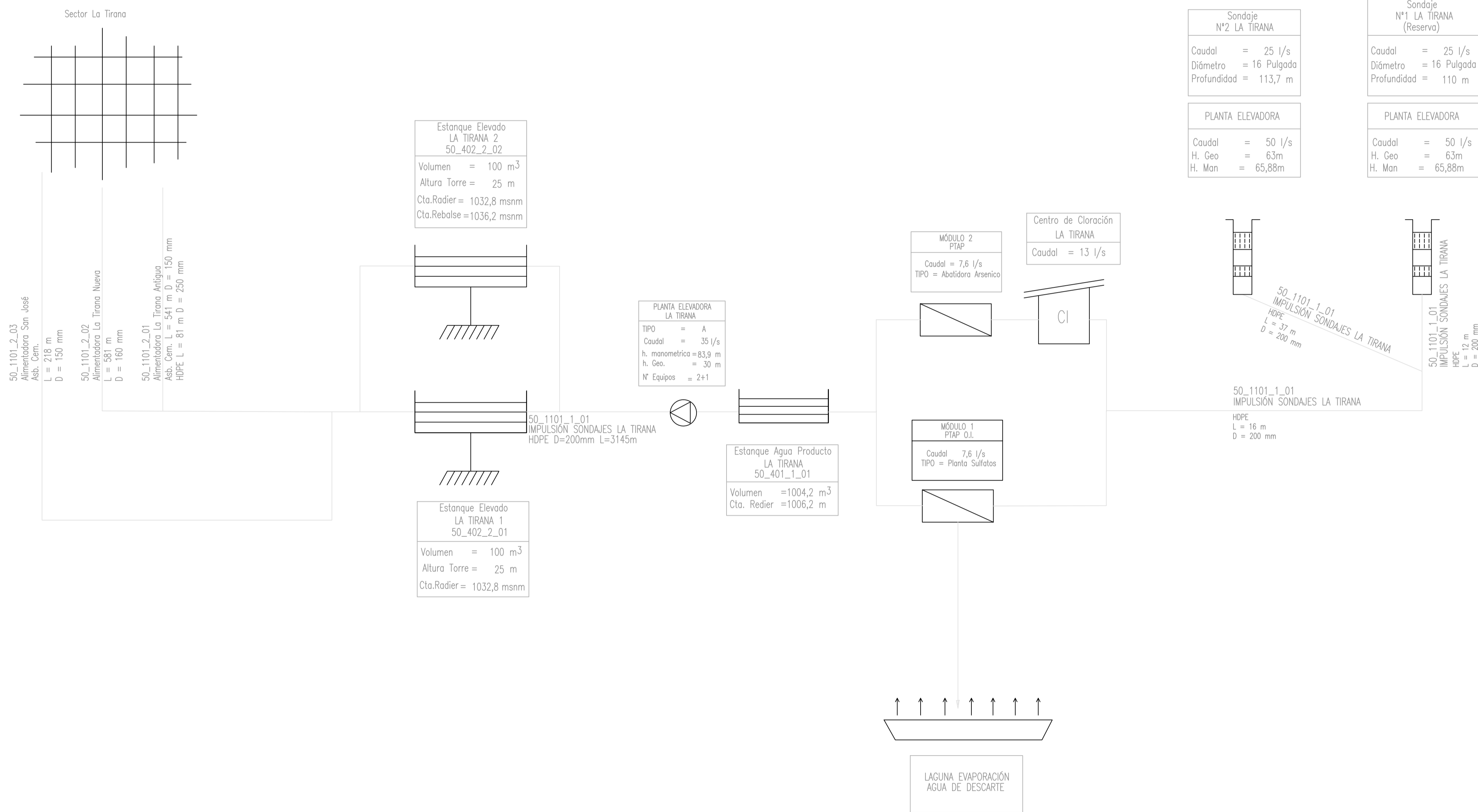

Sondaje N°2 LA TIRANA Caudal = 25 l/s Diámetro = 16 Pulgada Profundidad = 113,7 m	Sondaje N°1 LA TIRANA (Reserva) Caudal = 25 l/s Diámetro = 16 Pulgada Profundidad = 110 m
PLANTA ELEVADORA Caudal = 50 l/s H. Geo = 63m H. Man = 65,88m	PLANTA ELEVADORA Caudal = 50 l/s H. Geo = 63m H. Man = 65,88m

SIMBOLOGIA

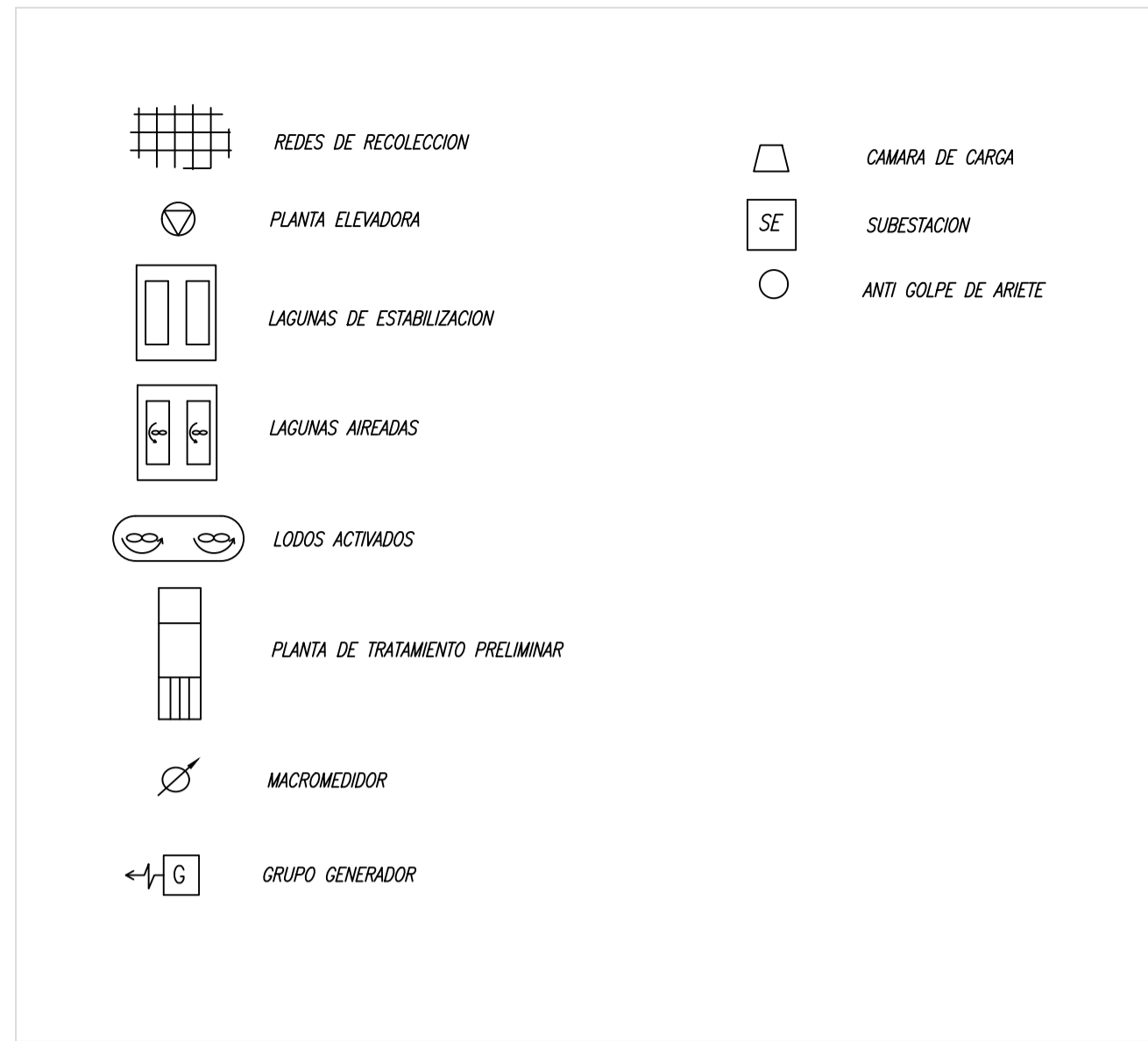

SISTEMA DE RECOLECCIÓN Y DISPOSICIÓN
LA TIRANA

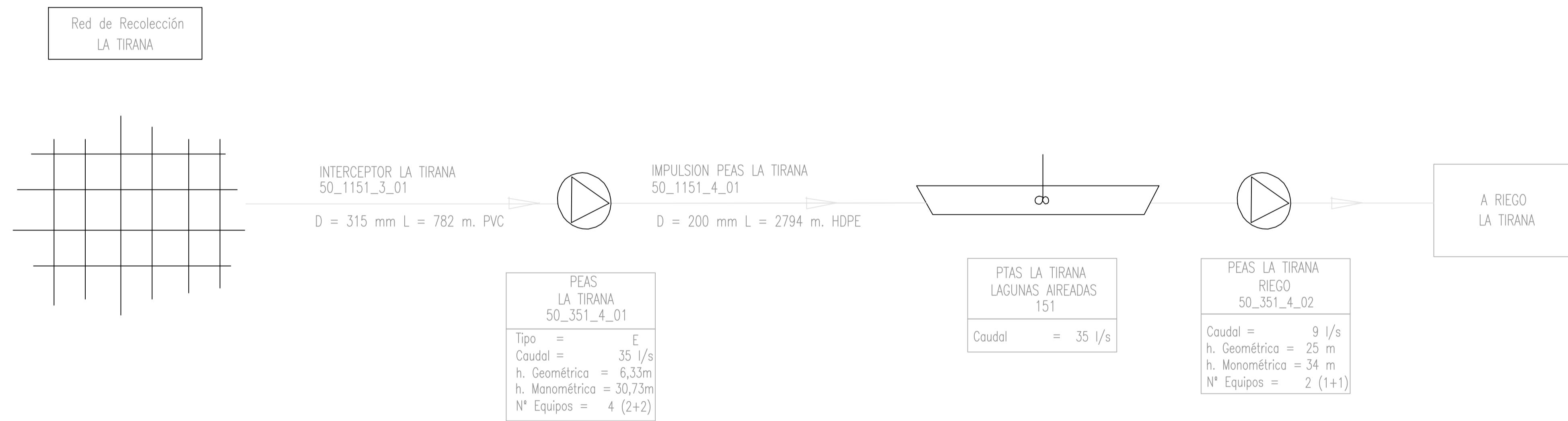

SIMBOLOGIA

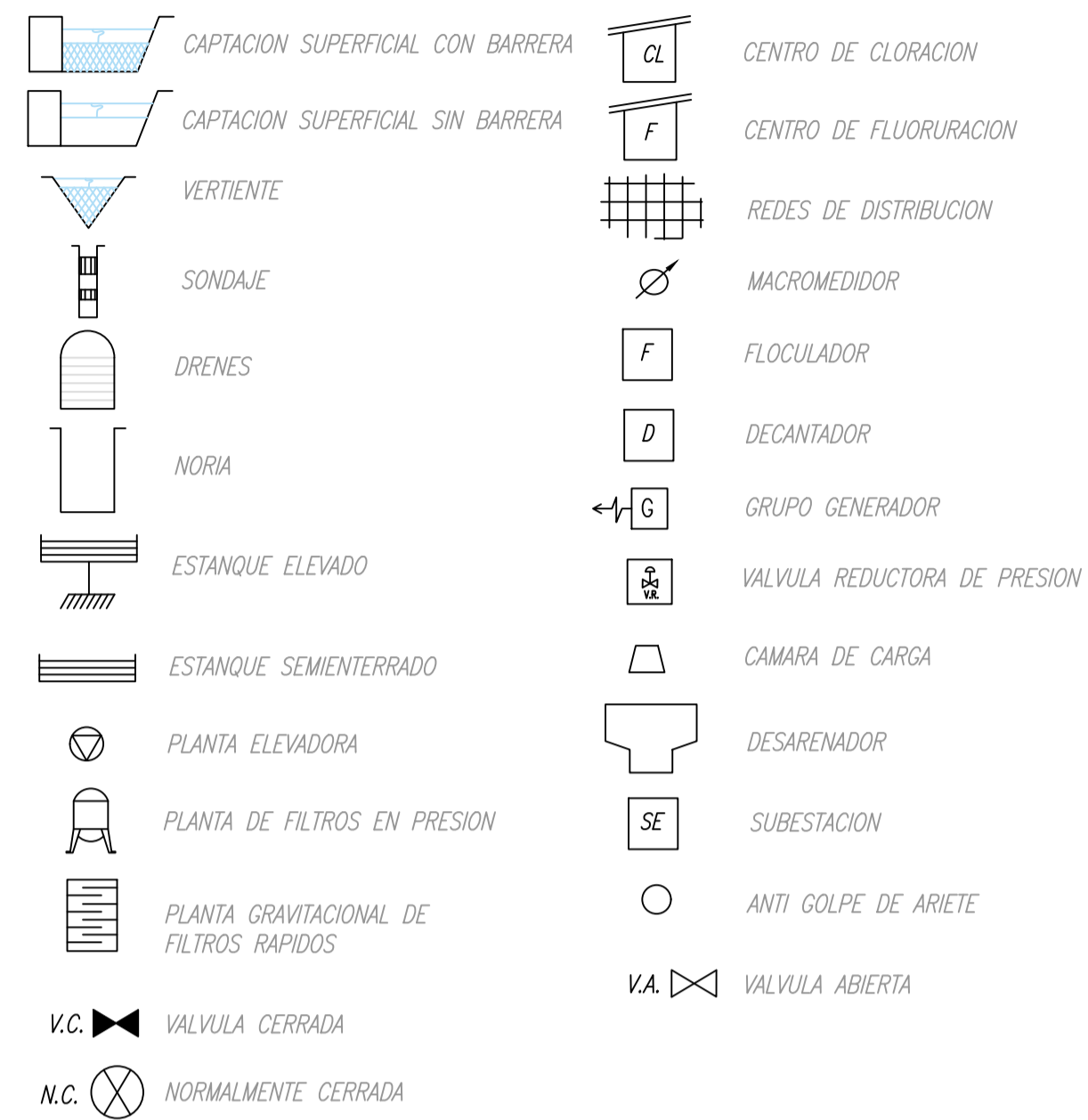

**SISTEMA DE PRODUCCIÓN – DISTRIBUCIÓN
LA TIRANA**

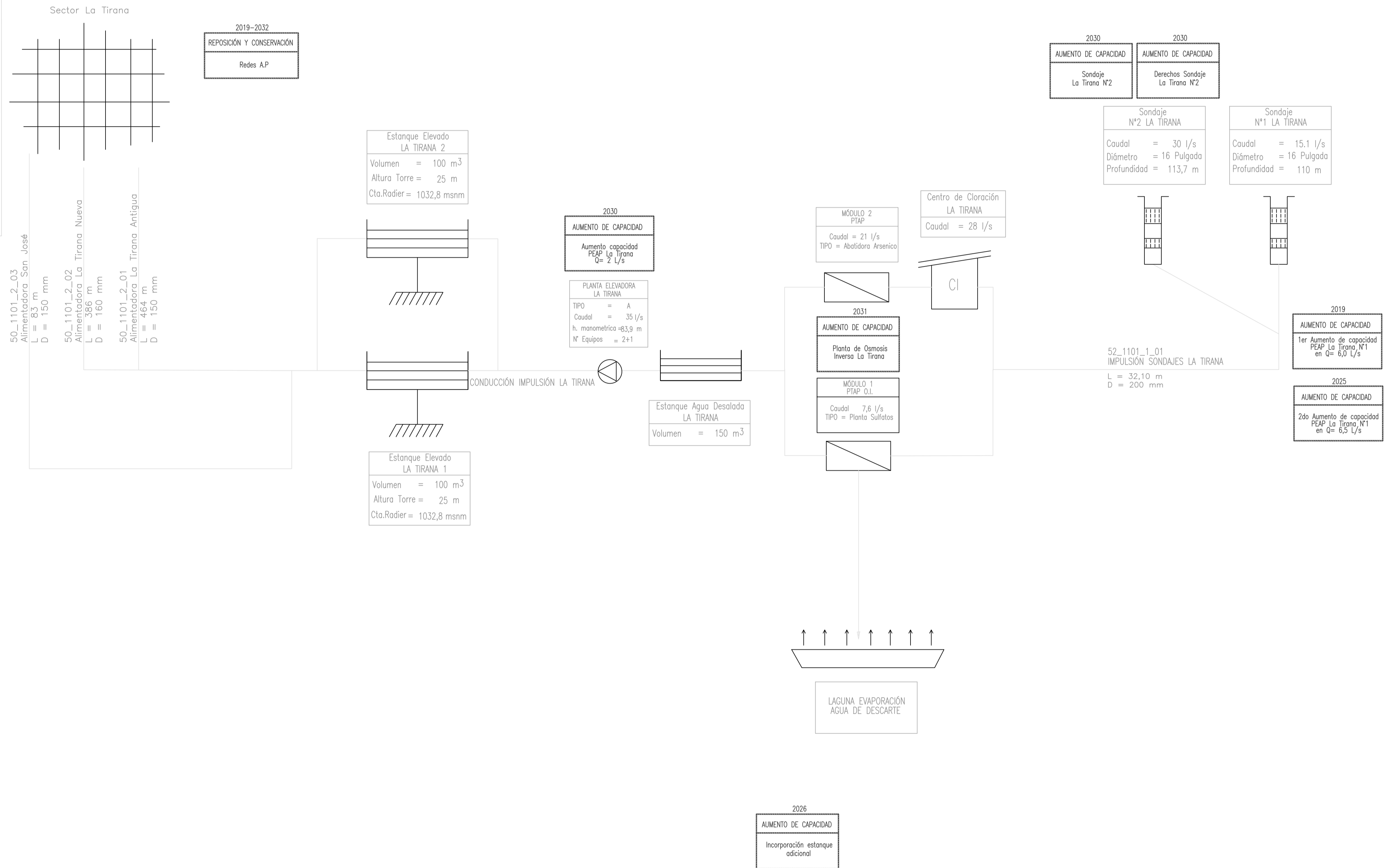

SIMBOLOGIA

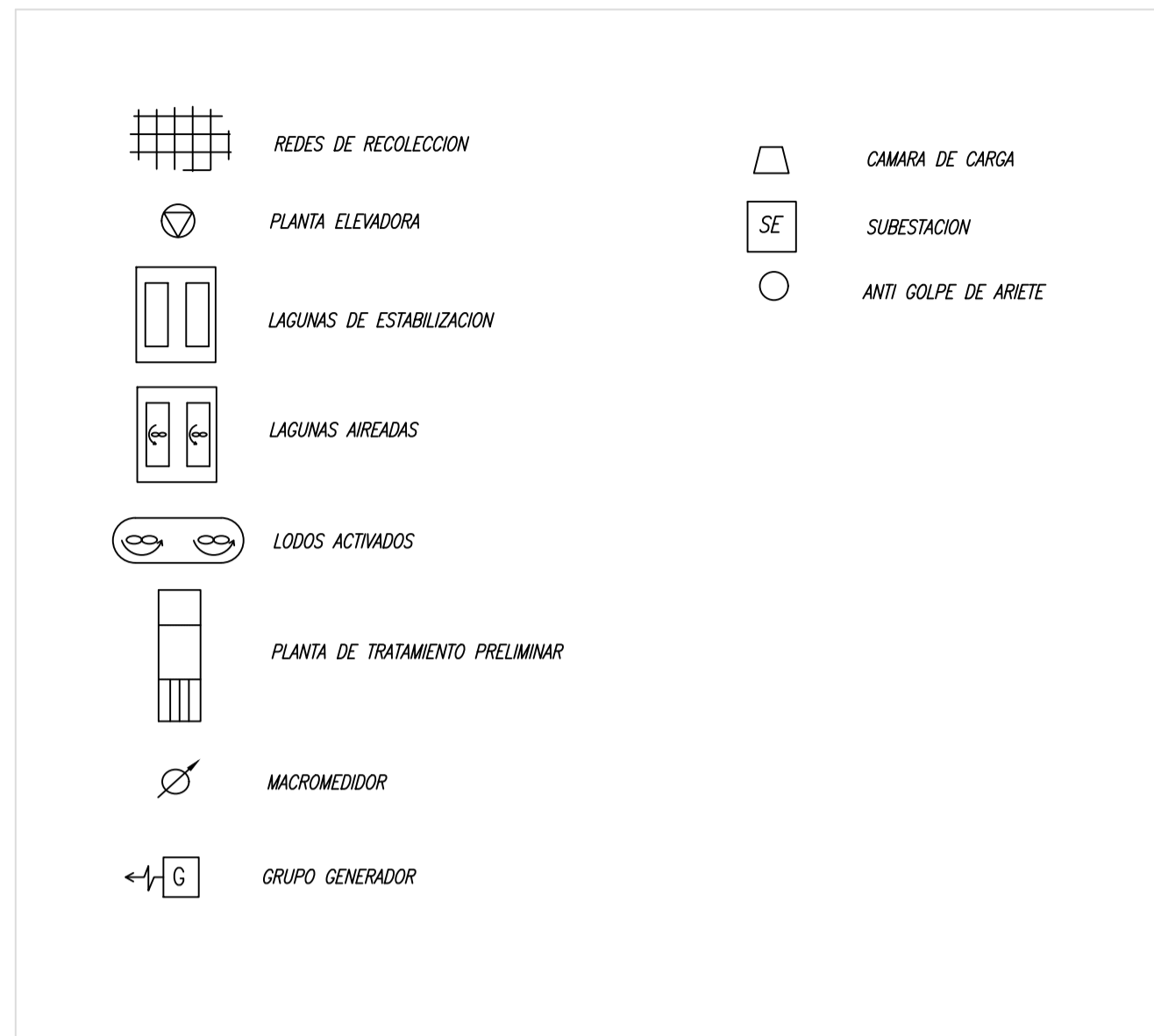

SISTEMA DE RECOLECCIÓN Y DISPOSICIÓN
LA TIRANA

